

SCHEDA TECNICA
DATA SHEET

Line

COFFEE TABLE



FINITURE DISPONIBILI | AVAILABLE FINISHES

FINITURE TAVOLINO LOW TABLE FINISHES

METALLO | METAL

MET.102 LACCATO CACAO | CACAO LACQUARED

MET.105 LACCATO CAPPUCCINO | CAPPUCCINO LACQUARED

FINITURE TOP TOP FINISHES

EB ESSENZA BASE | BASIC VENEERED

EP ESSENZA PLUS | PLUS VENEERED

PNA MARMO OPACO | MATT MARBLE

PNA MARMO LUCIDO | GLOSSY MARBLE

MODULARITÀ | MODULARITY

LINE 01, 02, 03

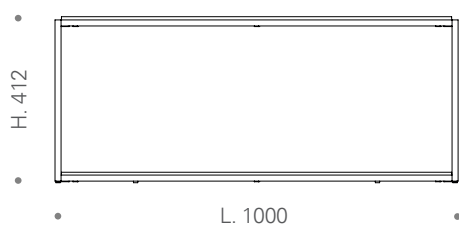

LINE 04

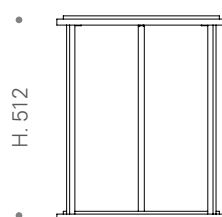

LINE 05

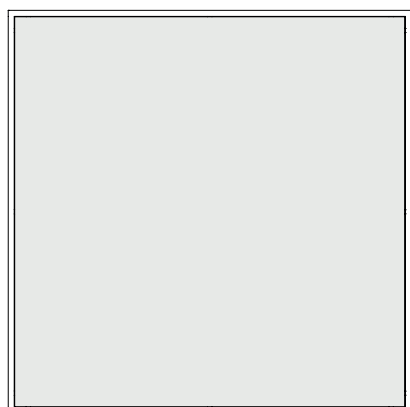
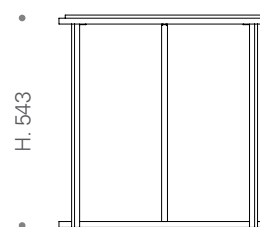

• P. 300 •
• P. 700 •
• P. 1000 •

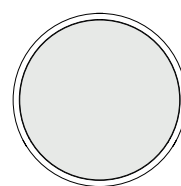

• D. 420 •

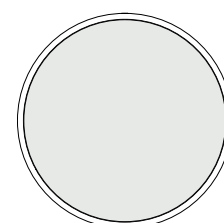

• D. 540 •

CARATTERISTICHE TECNICHE | TECHNICAL CHARACTERISTICS

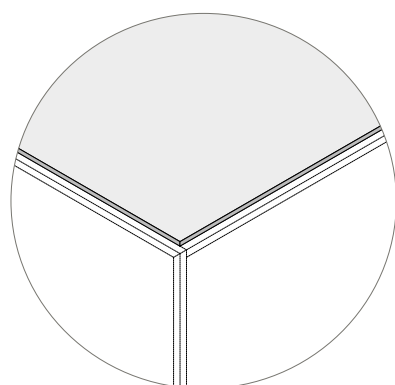

GESTIONE DEI PIANI | TOPS MANAGEMENT

Il doppio piano di appoggio, con cui è caratterizzata la collezione dei tavolini Line, viene gestito sempre con la monofinitura per garantire un'armonia estetica e funzionale. La finitura scelta nel piano superiore quindi, dovrà rispecchiare la stessa del piano inferiore. Es: se il piano inferiore è in Marmo Carrara (PNA.001) il piano inferiore seguirà la stessa linea e viceversa.

The double top, with which the Line coffee table collection is characterised, is always handled with a single finish to ensure aesthetic and functional harmony. The finish chosen for the upper top must therefore reflect the same as the lower top. E.g.: if the lower top is in Carrara Marble (PNA.001) the lower top will follow the same line.

KICO SRL

Via dell'industria 64032
Casoli di Atri - Teramo - ITALY

TEL +39 085.94 63 052
TEL +39 085.94 63 405
EMAIL info@kico.it
FAX +39 085.79 92 060

www.kico.it

Follow us on Instagram, Facebook,
Linkedin and Pinterest